

**[SAFETYDOORS.CO.UK](https://www.safetydoors.co.uk)**

A dark, modern door with a silver handle and a keyhole. The door is shown in a close-up, highlighting its sleek design and the metallic accents. The background is a dark, solid color, making the door stand out.

## Safety Doors

Our doors are beautifully designed and handcrafted to suit the exact specifications of our clients.

Our expert technicians are constantly on-hand to customize our products and tailor them to the tiniest detail.

We pride ourselves on our staff, who are trained and certified in every aspect of professional installation, and come from decades of experience in the field.

# Contents

|                       |    |
|-----------------------|----|
| Traditional Doors     | 3  |
| Contemporary Doors    | 6  |
| Commercial Doors      | 8  |
| Security Door Classes | 10 |
| Locks & Cylinders     | 16 |
| Millings              | 18 |
| Standard Carvings     | 19 |
| Door Finishes         | 21 |
| Door Ironmongery      | 25 |
| Available Upgrades    | 27 |
| Gallery               | 29 |

---

# Traditional Doors

Our doors are not only strong and stylish, but can also match traditional designs to make sure that your house looks like a home, not a fortress. At our company, we fully appreciate the importance of security. That's why we take great care to ensure our clients can have complete confidence in our work, giving them a genuine sense of safety – as well as style and sophistication. We can enhance even the most beautiful homes, equipping them with the strength and resilience of a fortress.

We specialise in designing and building security doors to meet your exacting and unique specifications. Whether you have your own bespoke designs, want a heritage replica, or something entirely custom, we use advanced 3D simulation and AutoCAD technology to bring your vision to life. Once we've carefully planned every detail, our state-of-the-art manufacturing facilities turn your ideas into reality with the utmost precision.

Accurate measurements, photographs of neighbouring properties, and physical samples of the original door are all used to engineer an exact replica that fully complies with Heritage regulations for conservation areas.



Traditional Doors



# Replica Doors

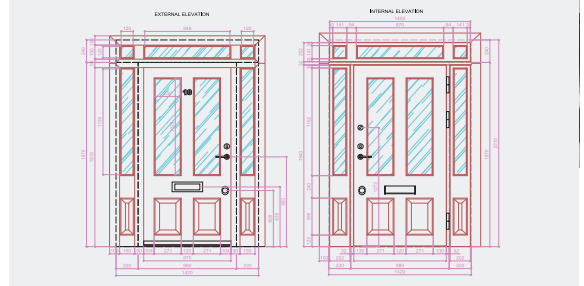
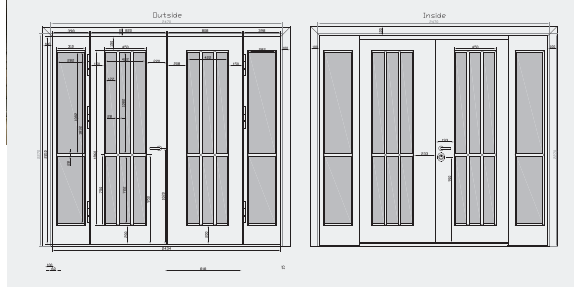
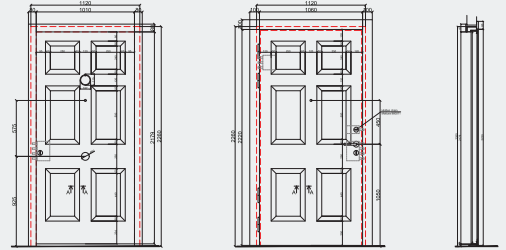

---

# Contemporary Doors

Our doors are designed to complement the style and ambiance of your beautiful home. Ensuring a perfect fit and providing maximum security and durability are our top priorities.

Every door we manufacture is meticulously designed and tested for accuracy using computerized processes throughout each stage of production to ensure the highest quality.

Every single aspect of your home's security will be guaranteed to be a hundred per cent impregnable in the hands of our staff.

You are free to choose any door design and colour, whether for inside or outside. This gives you the flexibility to seamlessly match your new door with your existing interior or exterior decor.

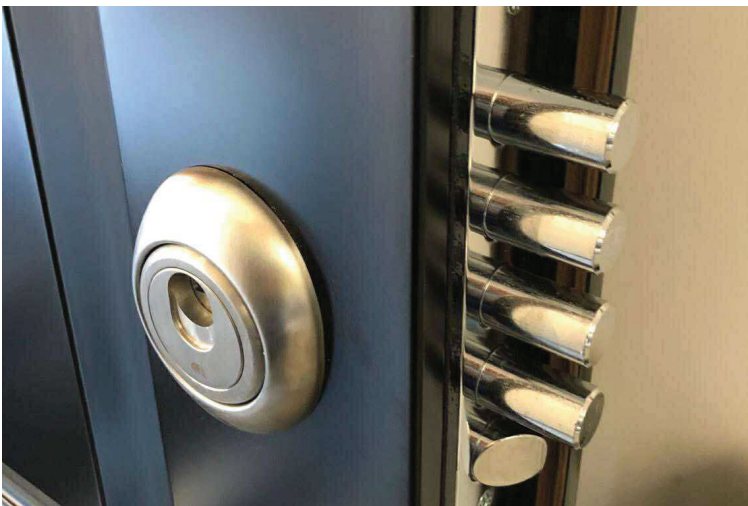

# Contemporary Doors



---

# Commercial Doors

Commercial premises are particularly vulnerable to break-ins, and statistics show that a property that has been burglarized once is four times more likely to be targeted again. Every intrusion increases the risk to your premises. Trust us to strengthen your business's defenses with robust, secure doors that protect your dreams and ideals, keeping out unwanted visitors and safeguarding what matters most.

While the needs of our commercial clients are different from our home-owners, we acknowledge that the core of these needs are similar: the need for security. Our commercial range of doors are engineered to suit the distinctively organisational look and purpose of a business, while strengthening our business clients from the very core of true security.



Commercial Doors

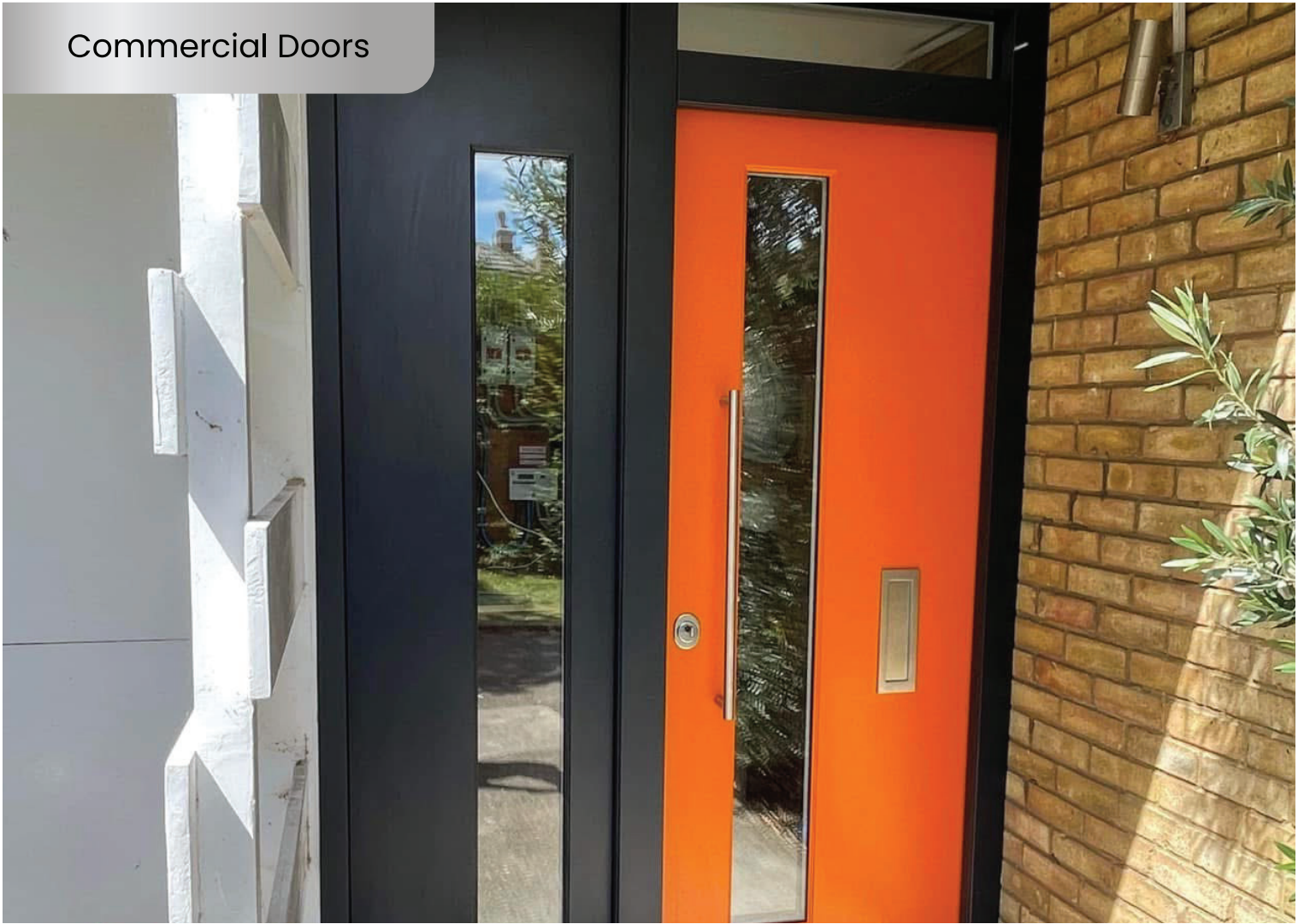

---

# Security Door Classes

## RC1 – Basic Security

1. Door frame – 80 mm wide special bended shape profile is fitted in to the wall by 8 screws 3.
2. Thermal insulation 50 mm rock wool.
3. Cut protective roll pins for door hinges (Ø12 mm) – 4 items.
4. Insulation seals – 2 items.

|                                |   |
|--------------------------------|---|
| <b>Oversize</b>                | Not possible  |
| <b>Number of hinges:</b>       | 2   |
| <b>Design &amp; colour</b>     | Any design and finish   |
| <b>Architraves:</b>            | Included, 80 mm x12 mm, 45°, Glued (no holes)   |
| <b>Colour of Metal constr.</b> | Any   |
| <b>Main Lock:</b>              | FIAM 678 multi-directional lock<br>ISEO R6 Plus (1 + 5 keys)  |
| <b>Hidden chain/night lock</b> | Not possible  |
| <b>Magnetic defender</b>       | Not possible  |
| <b>Outside handle/knob</b>     | Included  |
| <b>Inside handle</b>           | Included  |
| <b>Glass</b>                   | Not possible  |
| <b>Fire resistance</b>         | Possible for 30 min   |
| <b>Threshold:</b>              | Powder coated 15x20x80 mm   |
| <b>Metal construction:</b>     | For inside or outside conditions  |
| <b>Bullet resistance:</b>      | Not possible  |
| <b>Adjustable frame plate</b>  | n/a   |
| <b>Additional upgrades:</b>    | Spy hole<br>Overhead door closer<br>Drop down door seal<br>Security type letter box<br>Alarm sensor |
| <b>Packing:</b>                | Wooden box  |



## RC3 – High Security – 700 mm metal crowbar resistant

1. Door frame – 100 mm wide special bended shape profile is fitted in to the wall by 16 screws protected with Ø24mm steel liners.
2. Thermal insulation 50 mm rock wool.
3. Cut protective roll pins for door hinges (Ø16 mm) – 4 items.
4. Insulation seals – 2 items.

|                                |   |
|--------------------------------|---|
| <b>Oversize</b>                | Possible  |
| <b>Number of hinges:</b>       | 3, adjustable   |
| <b>Design &amp; colour</b>     | Any design, finish, shape and colour  |
| <b>Architraves:</b>            | Included, 100 mm, x12 mm 45°, Glued (no holes)  |
| <b>Colour of Metal constr.</b> | Any   |
| <b>Main Lock:</b>              | FIAM 678 multi-directional lock in protective metal box<br>ISEO R6 Plus (5 keys) key – thumb turn (modular)   |
| <b>Outside handle/knob</b>     | Included  |
| <b>Inside handle</b>           | Included  |
| <b>Glass</b>                   | Possible, security laminated, P5A, burglar proof  |
| <b>Fire resistance</b>         | Possible for 45 min   |
| <b>Threshold:</b>              | Stainless steel 15x20x100 mm  |
| <b>Metal construction:</b>     | For inside or outside conditions  |
| <b>Bullet resistance:</b>      | Possible up to FB4, standard steel  |
| <b>Adjustable frame plate</b>  | Included  |
| <b>Additional upgrades:</b>    | All the same as RC1 and below:<br>L-shape architraves<br>Motorised lock with finger print scanner, key pad or mobile phone connection<br>Concealed door closer<br>Extra MOTTURA bolts<br>Extra lock<br>Hidden chain/night lock<br>Magnetic defender |
| <b>Packing:</b>                | Wooden box  |

# Security Door Classes

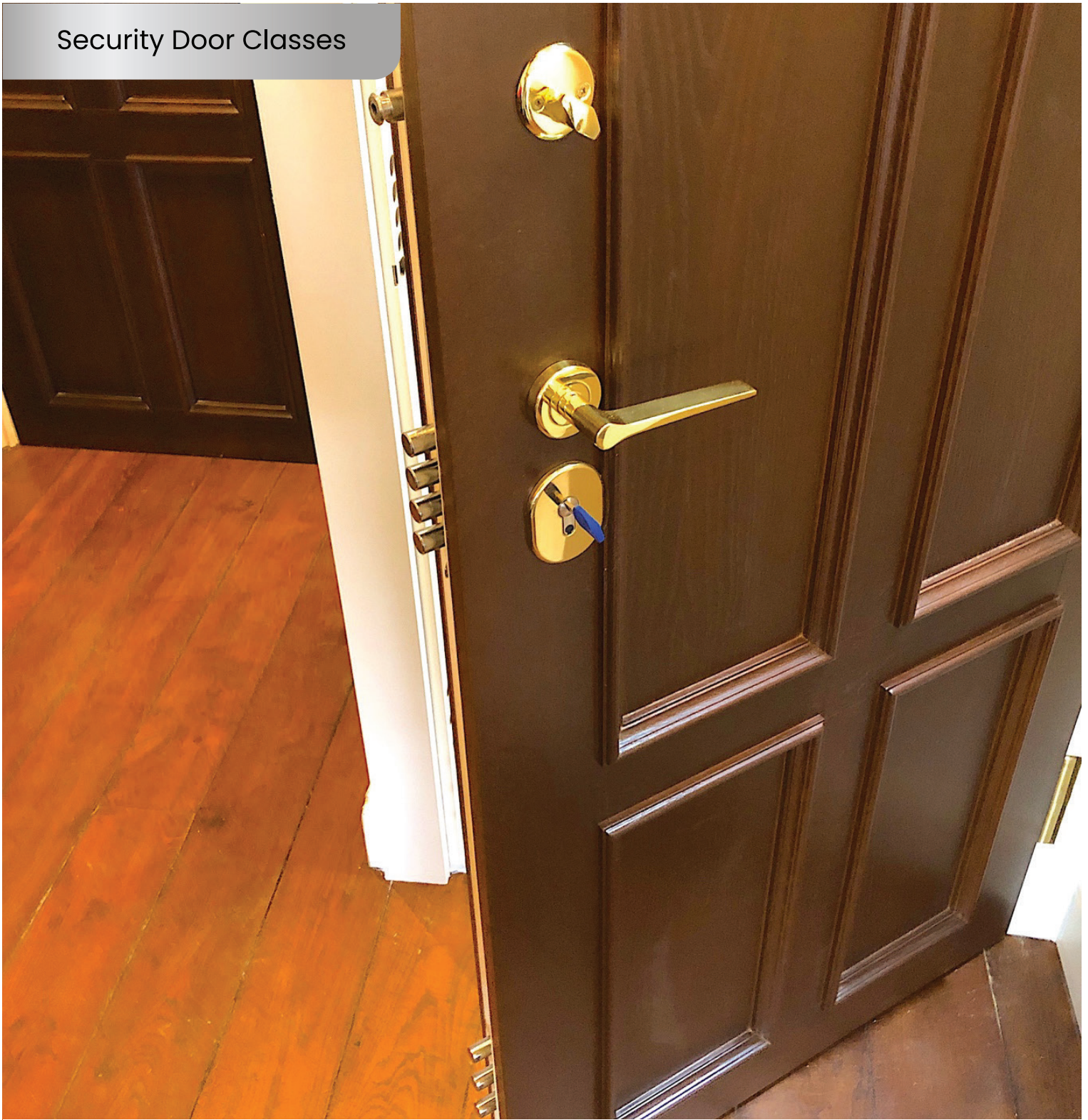

Cross section

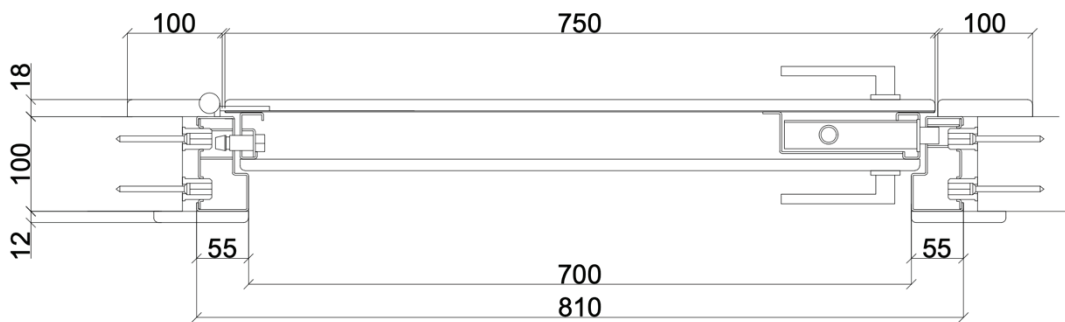

## RC4 – Highest Security – resistant to motorised tools

1. Door frame – 115 mm wide special bended shape profile is fitted in to the wall by 20 screws protected with Ø24mm steel liners.
2. Thermal insulation 60 mm rock wool.
3. Cut protective roll pins for door hinges (Ø16 mm) – 8 items.
4. Insulation seals – 2 items.

|                                 |   |
|---------------------------------|---|
| <b>Oversize</b>                 | Possible  |
| <b>Number of hinges:</b>        | 4, adjustable   |
| <b>Design &amp; colour</b>      | Any design, finish, shape and colour  |
| <b>Architraves:</b>             | Included, 100 mm, x12 mm 45°, Glued (no holes)  |
| <b>Main Lock:</b>               | MOTTURA 8th series (with deadplate) security grade 7, in protective metal box<br>MOTTURA CHAMPIONS PRO (3 keys)               |
| <b>Extra Lock:</b>              | Yes, DORMA (5 keys)   |
| <b>Hidden chain/night lock:</b> | Included  |
| <b>Magnetic defender:</b>       | Included (2 keys)   |
| <b>Outside handle</b>           | Included  |
| <b>Inside handle</b>            | Included  |
| <b>Glass</b>                    | Possible, security laminated, P6B, burglar proof  |
| <b>Fire resistance</b>          | Possible for 60 min   |
| <b>Threshold:</b>               | Stainless steel 15x20x115 mm  |
| <b>Metal construction:</b>      | For inside or outside conditions  |
| <b>Bullet resistance:</b>       | Possible up to FB6, BR6, standard steel or ballistic  |
| <b>Adjustable frame plate</b>   | Included  |
| <b>Additional upgrades:</b>     | All the same as RC3 and below:<br>Bullet resistant glass up to BR6<br>Ballistic steel up to FB6<br>Manganese anti drill plate |
| <b>MOTTURA bolts:</b>           | Yes @ the top and bottom of the door  |
| <b>Packing:</b>                 | Wooden box  |

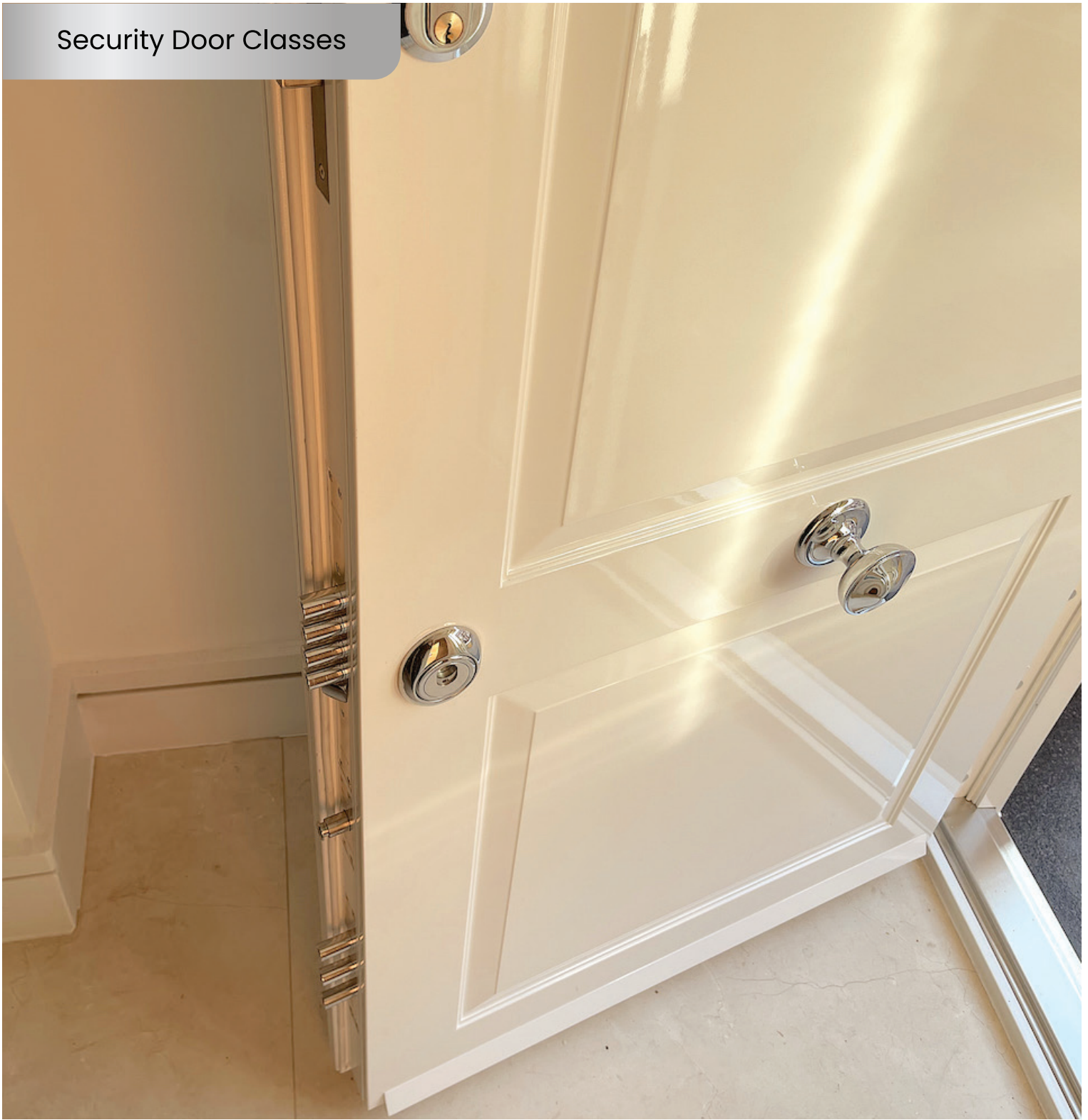

Cross section

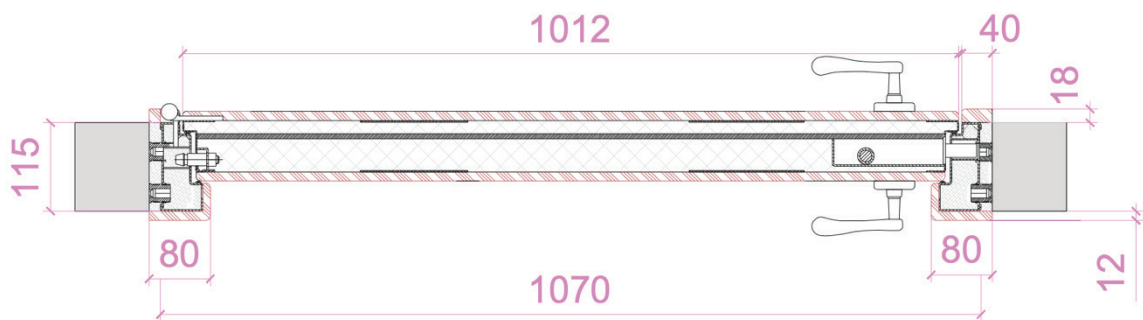

# Locks & Cylinders

**Mottura Class 7** by EN 12209 - Certification by EN 12209

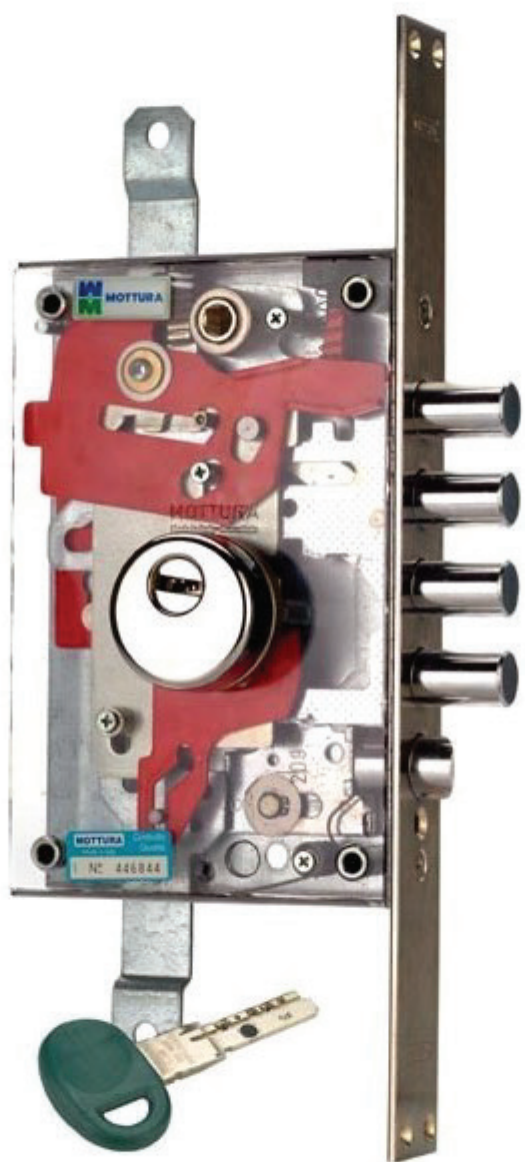

## Mottura 85783

- Armoured cylinder lock. Locks in three directions. Original CHAMPIONS cylinder with the protection DEFENDER. Higher security lock. The lock has a unique patented MOTTURA security system against knocking or pulling out the cylinder. If the cylinder is broken and pulled out while the lock is locked, the lock blocks up and cannot be unlocked.
- 5 small patented keys
- 7 locking points
- 7 security class
- Made in Italy
- Warranty - 3 years



## Champions C30/31

Double magnetic-mechanical coding system

- CHAMPIONS® 30 has five pins, of which one is positioned magnetically (patented)
- Shell and plug protected against drilling
- Widia pins
- Tempered steel anti-picklock shaped top and bottom pins
- Rest position of the cam off-centre with 30° respect to the cylinder profile to prevent it from exiting
- Possibility of master keying systems
- Frictioned cylinders available
- "Vario" option with 3 levels
- All thumb turn cylinders or provision for knob come frictioned standard
- A sealed packet includes the cylinder, owner's card, keys, installation instructions and fixing screw. For maximum security, keys and owner's card are sealed from the manufacturer
- The cylinders marked BKC are certified as bump-resistant



## FIAM

- Main 3-point lock for security doors complete with a strike.
- Massive body, 4 bolts.
- Reversible latch.
- The silence of work and high burglary resistance of that lock is due to his patented gear mechanism.
- \* Also available with anti-snap mechanical block system – if the protector and locking cylinder is broken the lock blocked automatically and cannot be opened without destruction.



## ISEO R6 Plus R6 Plus

- 6 billies, in a straight arrangement
- Safety shell with wills, inverted (double-sided)
- Delivered with 5 keys and 1 draft construction site
- Steel billies so that it can not be easily punctured (protection anti-drilling)
- Specially made billies against finding the key code (anti-picking protection)

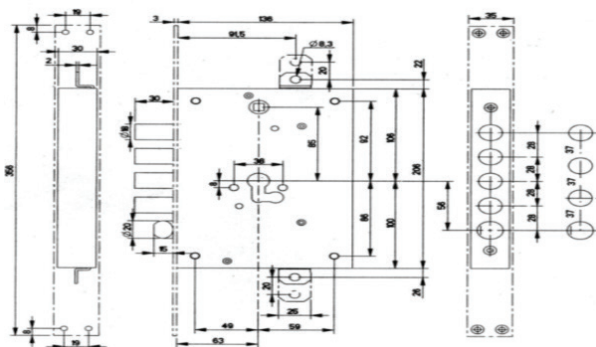

# FIAM®

# Millings

To enhance the beauty of our doors, we apply a high-quality exterior skin made from natural wood, veneer, plywood, or laminated materials. We also offer a wide selection of PVC films that mimic various wood finishes. Our exterior doors are wind-resistant, offer excellent thermal insulation, high soundproofing, and are waterproof. They are designed to stay attractive for many years. To ensure durability and top quality, we use specially selected, certified waterproof EDM for the finish of our entrance doors. Whether finished with paint or PVC laminate, our doors are easy to maintain and simple to clean.

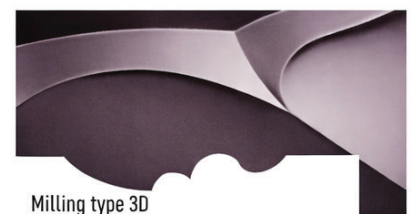
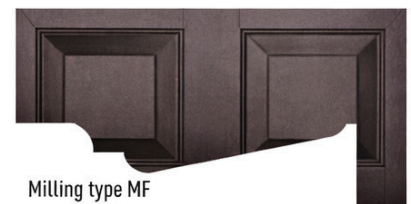
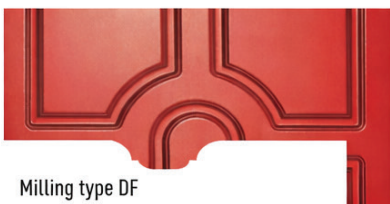
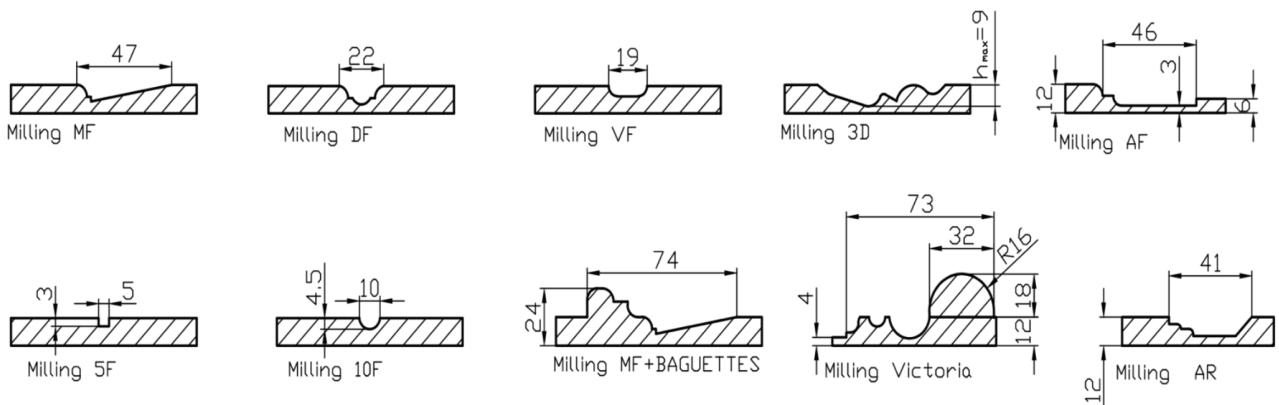

# Standard Carvings

Choose a design from our range of nearly 200 carvings. Alternatively we will make your door from drawings prepared either by you, us or your architect.

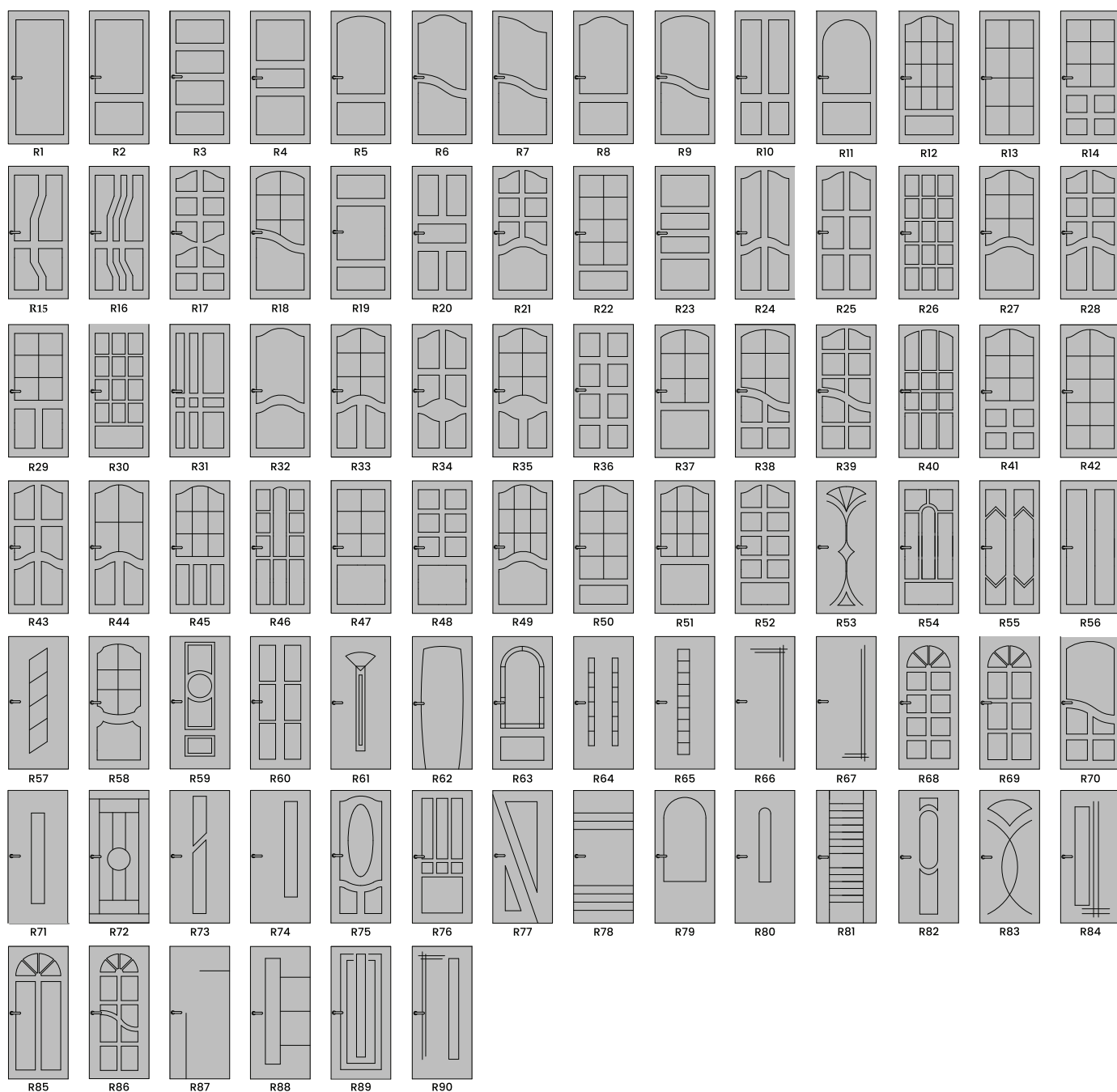

# Standard Carvings

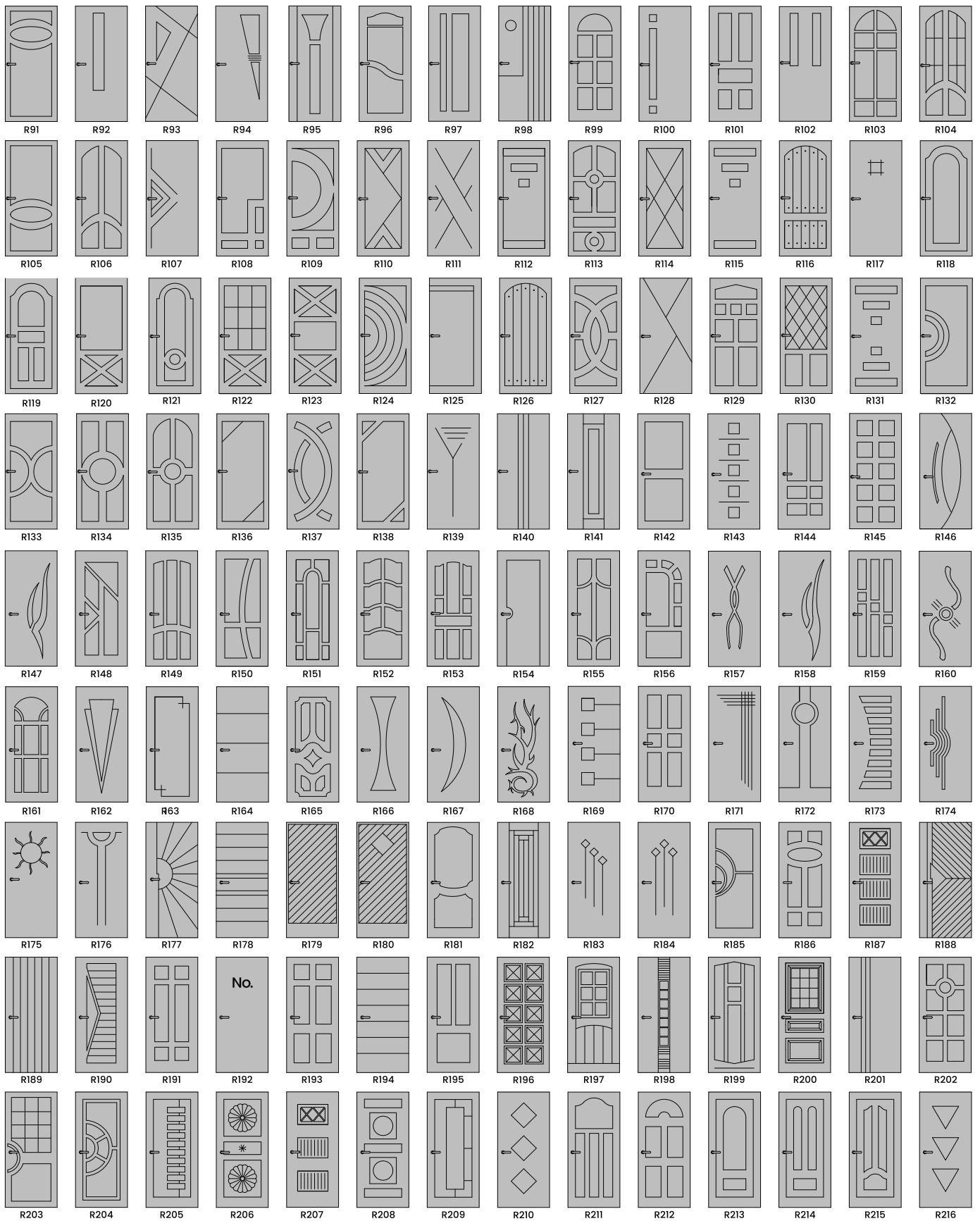

# Door Finishes

## Painting Colours



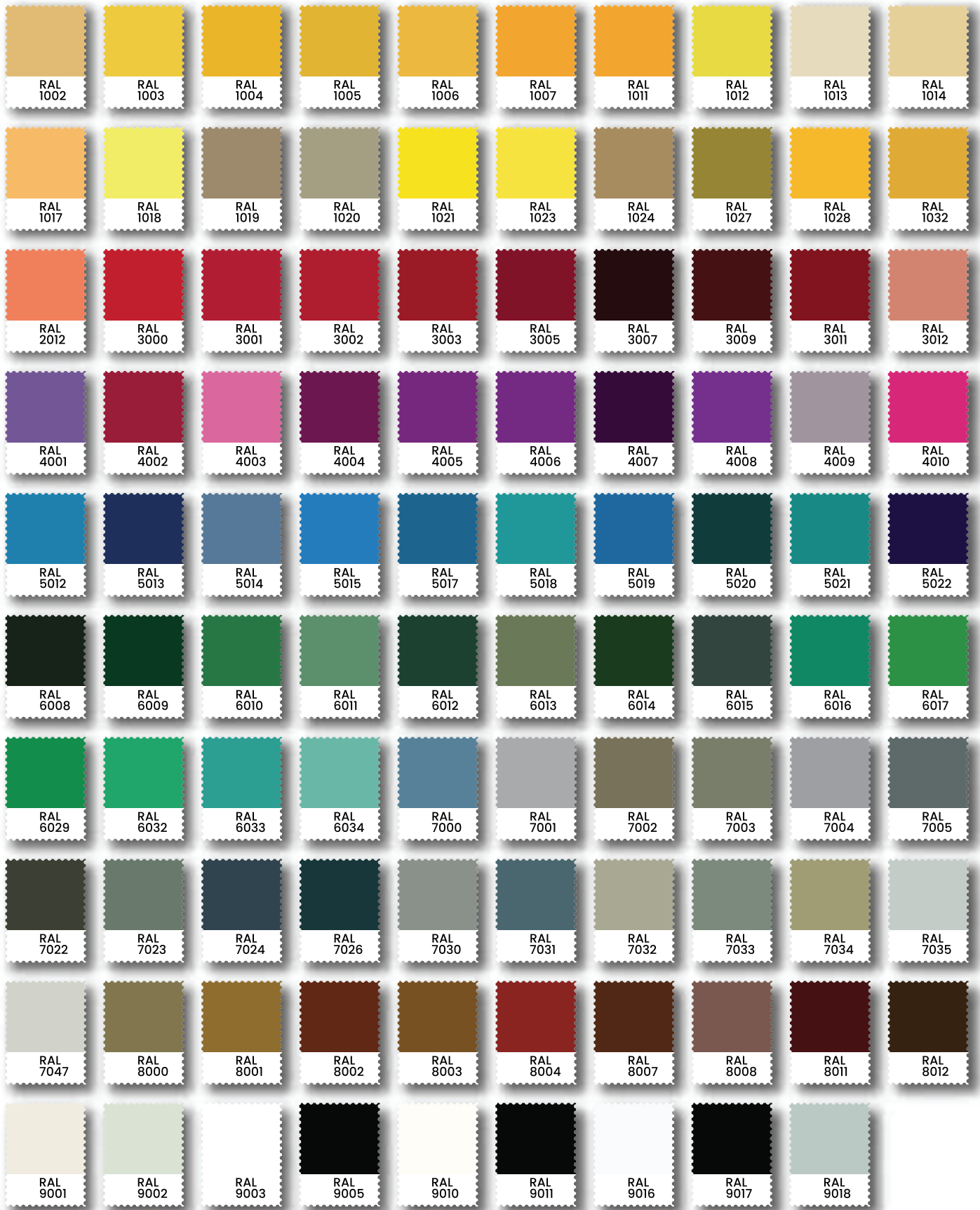

# Metal Colours

The internal construction of the doors has no closed cavities, so the entire construction can be powder-coated in the following colours, providing long-term surface protection from corrosion.

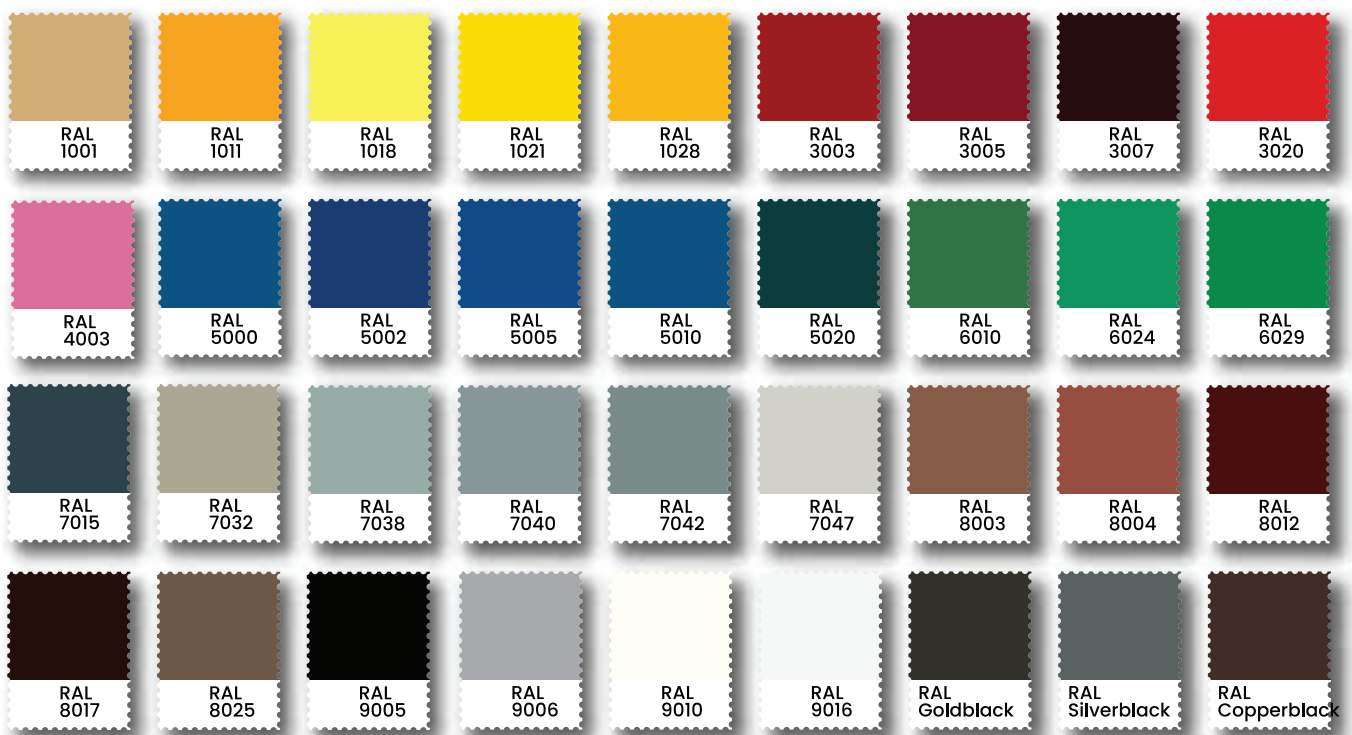

# PVC film colours

PVC laminated MDF or Umidax-HLS board is especially resistant to scratching and chipping of corners.





# Door Ironmongery

Just as you chose your door design and colours, you are free to select your ironmongery as well. We offer a wide variety of knobs, handles, and knockers, available in polished chrome, satin chrome and polished brass finishes. If you can't find exactly what you're looking for, we're here to help. Our goal is not only to secure your premises but also to bring your design vision to life.





---

# Available Upgrades



Magnetic Defender



Drop Down Seal



Additional MOTTURA Bolts



Additional Locks



Concealed Door Closer



Night Chain



High Gloss

---

# Gallery









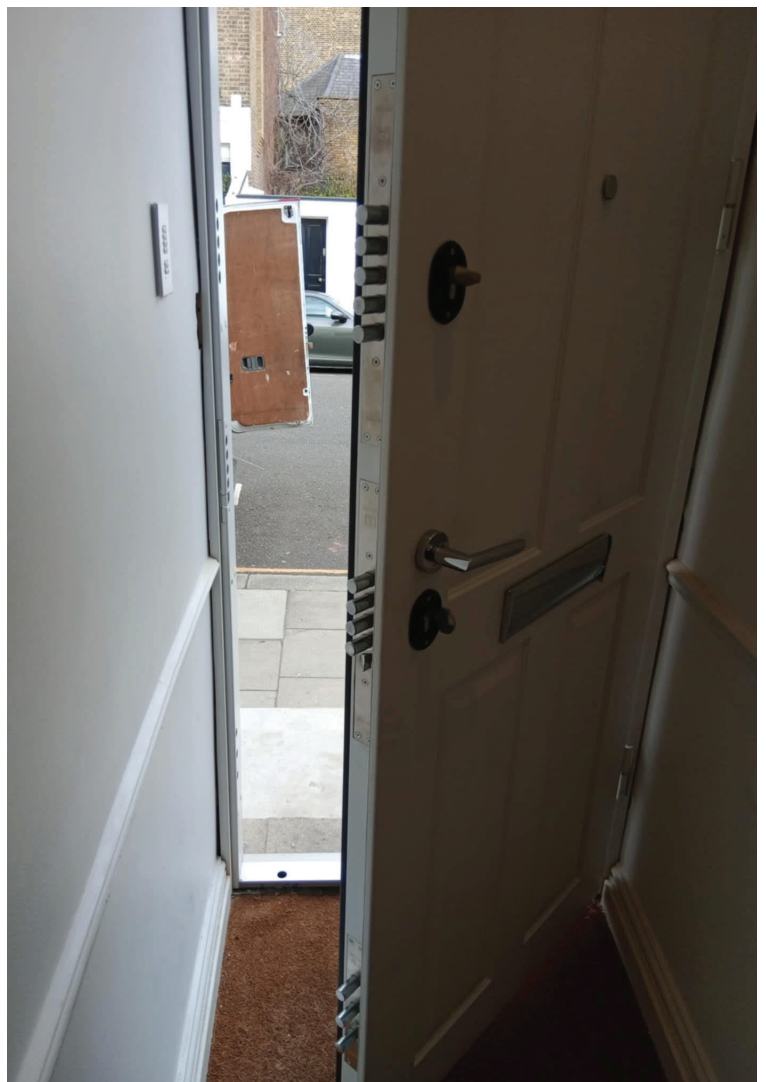

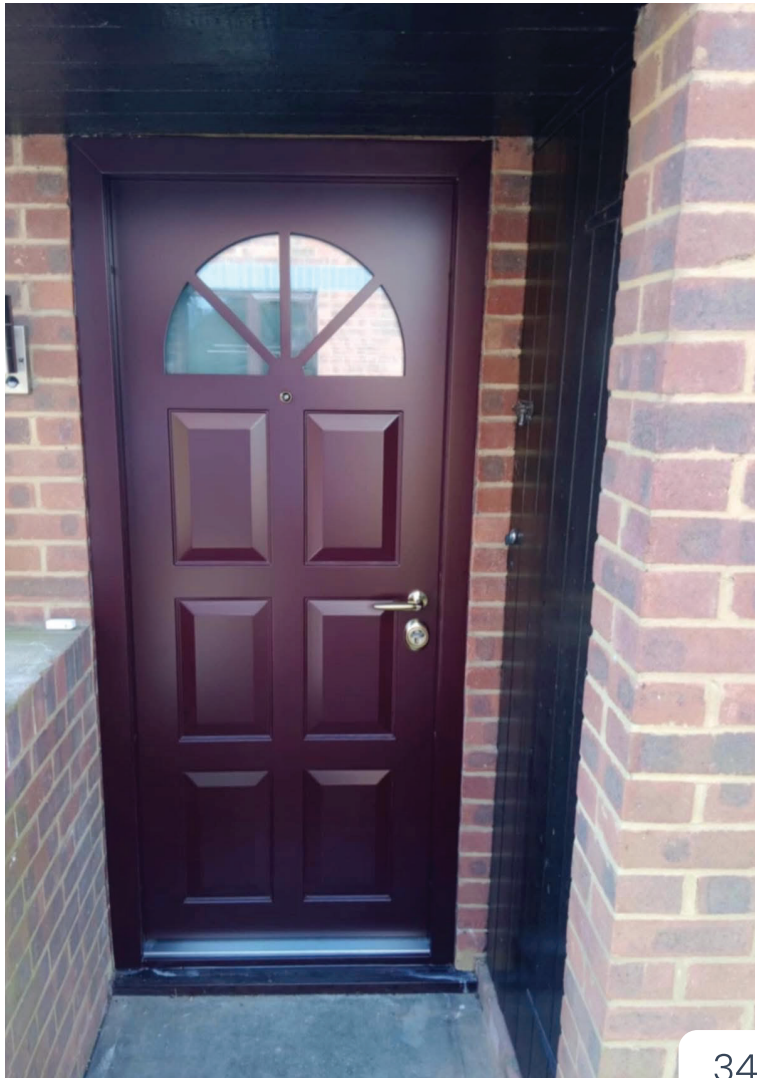



[SAFETYDOORS.CO.UK](https://www.safetydoors.co.uk)

### **Safety Doors LTD**

3-6 NDC Unit, Banister Road,  
London, W10 4AR  
Company number: 13247361

### **Contact Us**

+44 (0) 20 8099 9220  
+44 (0) 77 7767 0272  
[info@safetydoors.co.uk](mailto:info@safetydoors.co.uk)